

waterpik®

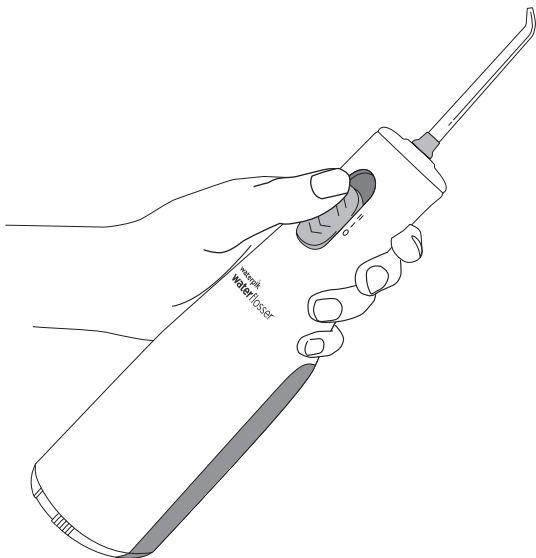

Waterpik® Water Flosser Model WF-02

.....
www.waterpik.com

TABLE OF CONTENTS

Important Safeguards	3
Product Description	5
Getting Started	7
Cleaning and Troubleshooting Your Waterpik® Water Flosser	8
Limited One-Year Warranty	10

IMPORTANT SAFEGUARDS

When using electrical products, especially when children are present, basic safety precautions should always be followed, including the following:

READ ALL INSTRUCTIONS BEFORE USING.

WARNING:

To reduce the risk of injury to persons:





- Do not direct water under the tongue, into the ear, nose or other delicate areas. This product is capable of producing pressures that may cause serious damage in these areas.
- Use this product only as indicated in these instructions or as recommended by your dental professional.
- Do not use lithium batteries in this product. These batteries are capable of producing pressures that may be uncomfortable to the user and may also result in damage to the appliance. Use of lithium batteries will void the warranty.

- Only use tips and accessories that are recommended by Water Pik, Inc.
- Do not drop or insert any foreign object into any opening on the product.
- Do not use this product outdoors or operate where aerosol (spray) products are being used or where oxygen is being administered.
- Do not use iodine, bleach, or water insoluble concentrated essential oils in this product. Use of these can reduce product performance and will shorten the life of the product.
- Fill reservoir with water or other dental professional recommended solution only.
- Remove any oral jewelry prior to use of this product.
- Do not use if you have an open wound on your tongue or in your mouth.
- If your physician advised you to receive antibiotic premedication before dental procedures, you should consult your dentist before using this instrument or any other oral hygiene aid.
- Close supervision is necessary when this product is used by, on or near children or invalids.
- Children should be supervised to ensure that they do not play with the appliance.

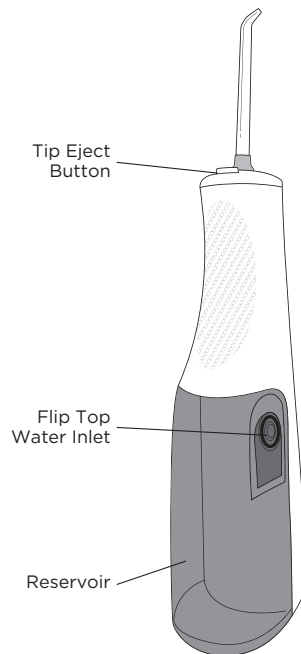
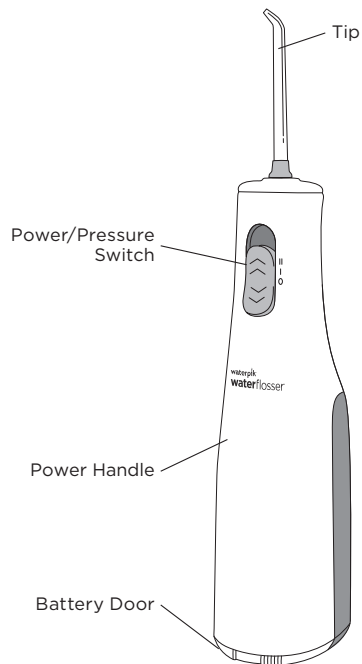
SAVE THESE INSTRUCTIONS.

PRODUCT DESCRIPTION



Replace Every 3 Months	
Orthodontic Tip	BEST FOR
	<input checked="" type="checkbox"/> Braces <input checked="" type="checkbox"/> General Use
Pik Pocket™ Tip	BEST FOR
	<input checked="" type="checkbox"/> Periodontal Pockets <input checked="" type="checkbox"/> Furcations
Plaque Seeker® Tip	BEST FOR
	<input checked="" type="checkbox"/> Implants <input checked="" type="checkbox"/> Retainers <input checked="" type="checkbox"/> Crowns <input checked="" type="checkbox"/> General Use <input checked="" type="checkbox"/> Bridges
Toothbrush Tip	BEST FOR
	<input checked="" type="checkbox"/> General Use

Replace Every 6 Months	
Classic Jet Tip	BEST FOR
	<input checked="" type="checkbox"/> General Use
Tongue Cleaner	BEST FOR
	<input checked="" type="checkbox"/> Fresher Breath

NOTE: All tips not included in all models.

Replacement tips can be purchased from your local distributor, which can be found at www.waterpik.com/intl.

Inserting Batteries

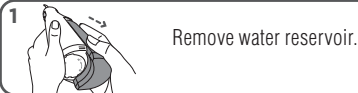

1 Remove water reservoir.



2 Twist battery door left from the locked position to unlocked position and pull battery door away from the unit.

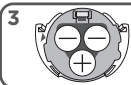

3 Insert 3 AA batteries as shown.

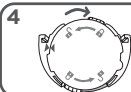

4 To replace battery door, line-up arrows, push and twist.

Replace batteries when there is a noticeable change in performance.

Filling the Reservoir

Lift the flip top on reservoir and fill the reservoir with lukewarm water.

Inserting and Removing Tips

Insert tip into the center of the knob at the top of the Water Flosser handle. The colored ring will be flush with the end of the knob if the tip is correctly

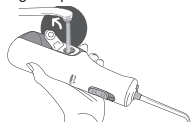

locked into place. To remove the tip from the handle, press the tip eject button and pull tip from handle.

Adjusting the Pressure Setting

You can adjust the pressure setting on your Water Flosser by simply sliding the pressure/power switch on the handle. Slide power switch up 1 click for low (I) pressure and 2 clicks for high (II) pressure.

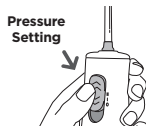

Recommended Technique

Lean low over sink and place the tip in mouth.

Aim the tip toward teeth, and turn the unit ON (I).

For best results, start with the back teeth and work toward the front teeth. Glide tip along gumline and pause briefly between teeth. Continue until you have cleaned the inside and outside of both the upper and lower teeth.



Direct the jet stream at a 90-degree angle to your gumline. **Slightly close lips to avoid splashing** but allow water to flow freely from mouth into the sink. Keep unit upright during use for best results.

When Finished

Turn the unit off. Empty any liquid left in the reservoir.

If desired, the reservoir may be removed from the power handle by sliding the reservoir down towards the base of the unit.

To replace the reservoir on the power handle, simply slide it up towards the top of the unit.

CLEANING AND TROUBLESHOOTING YOUR WATERPIK® WATER FLOSSER

TIP USAGE

Pik Pocket™ Tip

The Pik Pocket™ Tip is specifically designed to deliver water or anti-bacterial solutions deep into periodontal pockets.

To use the Pik Pocket™ Tip, **set the unit to the lowest pressure setting**. Place the soft tip against a tooth at a 45-degree angle and gently place the tip under the gumline, into the pocket. Turn the unit on and continue tracing along the gumline.

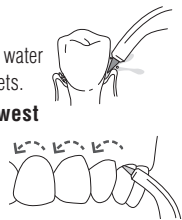

Tongue Cleaner Tip

To use the tongue cleaner tip, set to lowest pressure setting, place tip in the center/middle of your tongue about half way back and start the Water Flosser. Pull forward with light pressure. Increase pressure as you prefer.



Orthodontic Tip

To use the Orthodontic Tip, gently glide tip along gumline, pausing briefly to lightly brush area between teeth and all around orthodontic bracket, before proceeding to the next tooth.

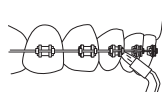

Toothbrush Tip

Place the toothbrush tip in mouth with the brush head on the tooth at the gumline. The toothbrush tip can be used with or without toothpaste. Turn the Water Flosser on so the water flows through



the tip. Using a **light pressure** (bristles should not bend) massage the brush back and forth with very short strokes—much like you would with a manual toothbrush.

Plaque Seeker® Tip

To use the Plaque Seeker® Tip, place the tip close to the teeth so that the bristles are gently touching the teeth. Gently glide tip along gumline, pausing briefly between teeth to gently brush and allow the water to flow between the teeth.



Using Mouthwash and Other Solutions

Your Waterpik® Water Flosser can be used to deliver mouthwash and antibacterial solutions. After using any special solution, rinse unit to prevent clogging by partially filling reservoir with warm water and running unit with tip pointed into sink until unit is empty.

Cleaning

Never immerse unit in water. Clean the product when necessary by using a soft cloth and mild non-abrasive cleanser to wipe exterior.

The water reservoir is removable for easy cleaning and is top rack dishwasher safe. It is recommended that the reservoir is removed and cleaned weekly.

Removing Hard Water Deposits

Hard water deposits may build up in your unit, depending on the mineral content of your water. If left unattended, it can hinder performance. Cleaning internal parts: add 2 tablespoons of white vinegar to a full

reservoir of warm water. Point the handle and tip into sink. Turn unit ON and run until reservoir is empty. Rinse by repeating with a full reservoir of clean warm water.

This process should be done every 1 to 3 months to ensure optimal performance.

AA Battery Care and Disposal

- Alkaline batteries and NiMH rechargeable batteries are acceptable.
- Batteries are to be inserted with the correct polarity.
- Exhausted batteries are to be removed from the Water Flosser and properly disposed.
- The supply terminals are not to be short-circuited.
- Do not dispose of batteries in fire.
- The type and quality of AA battery used will impact performance of the product.
- Replace all batteries at the same time with new batteries of the same type and brand.
- Replace batteries when there is a noticeable change in performance.
- Remove batteries when the appliance will not be used for a long period of time.

WARNING: Use of lithium batteries will void the warranty and may also result in damage to the appliance.

Service Maintenance

Waterpik® Water Flossers have no consumer-serviceable electrical items and do not require routine service maintenance. For all your service needs go to www.waterpik.com/intl to find your local distributor. Please do not ship product to Waterpik International, Inc. offices, this will delay service.

Refer to the serial and model numbers in all correspondence. These numbers are located on the bottom of your unit.

Distributed By:

Brandfarm Pty Ltd
10 Narabang Way
Belrose NSW 2085
+61 2 8860 6463

Replacement tips can be purchased from your local distributor, which can be found at www.waterpik.com/intl.

LIMITED ONE-YEAR WARRANTY

Water Pik, Inc. warrants to the original purchaser/owner of this new product that it is free from defects in materials and workmanship for one year from date of purchase. Save your receipt as your proof of purchase date. Water Pik, Inc. reserves the right to request the product to be returned for analysis to confirm the claim falls within our warranty policy. We will replace any part of the product, which in our opinion is defective, provided the product has not been abused, misused, altered or damaged after purchase and was used according to these instructions. This limited warranty excludes accessories or consumable parts such as tips, etc.

Water Pik, Inc. will not be responsible for any expenses incurred as a result of any warranty claim accepted by Water Pik, Inc. This warranty gives you specific additional legal rights to those which you may have depending on the law in your place of residence.

Our goods come with guarantees that cannot be excluded under the Australian Consumer Law. You are entitled to a replacement or refund for a major failure and for compensation for any other reasonably foreseeable loss or damage. You are also entitled to have the goods repaired or replaced if the goods fail to be of acceptable quality and the failure does not amount to a major failure.

To make a warranty claim and before sending the product, please contact:

Brandfarm Pty Ltd
Australia & New Zealand Contact Details

10 Narabang Way
Belrose NSW 2085
[P] +61 2 8860 6463

This warranty is given by:
Water Pik, Inc.
1730 East Prospect Road
Fort Collins, CO 80553-0001
USA



Water Pik, Inc.

1730 East Prospect Road

Fort Collins, CO 80553-0001 USA

www.waterpik.com

Distributed By:

Brandfarm Pty Ltd

Australia & New Zealand Contact Details

10 Narabang Way

Belrose NSW 2085

[P] +61 2 8860 6463

www.waterpik.com.au

Waterpik® is a trademark of Water Pik, Inc. registered in Argentina, Australia, Benelux, Brazil, Canada, Chile, China, Czech Republic, Denmark, EU, Finland, France, Germany, Hong Kong, Hungary, India, Israel, Italy, Japan, Korea, Mexico, New Zealand, Norway, Pakistan, Poland, Russian Federation, Saudi Arabia, Singapore, South Africa, Spain, Sweden, Switzerland, Taiwan, Turkey, Ukraine, United Kingdom, and the United States.

Waterpik® (stylized) is a trademark of Water Pik, Inc. registered in Australia, Brazil, Canada, China, EU, Hong Kong, Israel, Japan, Korea, Mexico, Russian Federation, Saudi Arabia, South Africa, Switzerland, Trinidad & Tobago, and the United States.

Pik Pocket™ is a trademark of Water Pik, Inc.

Plaque Seeker® is a trademark of Water Pik, Inc. registered in Canada, China, EU, and the United States.

Designed in USA. Made in CHINA.

Form No. 20020427-F AA

©2016 Water Pik, Inc.